

Note:<注意>
 Electrical:<电气性能>
 .Rated current & voltage: DC 12V, 3A
 <额定电压, 电流: DC 12V, 3A>
 .Contact resistance: 50 milliohm Max.
 <接触阻抗: 50 milliohm Max.>
 100% open & short test.
 <100% 导通, 短路测试>

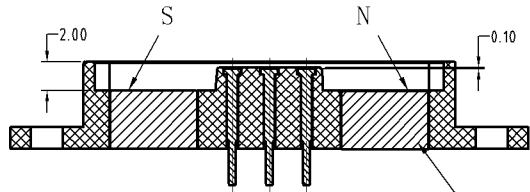

Approve Sign

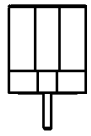
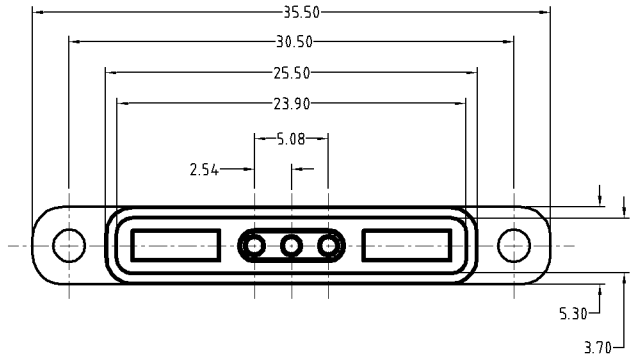

磁铁点胶固定, 不会被吸附出来

剖面 A-A

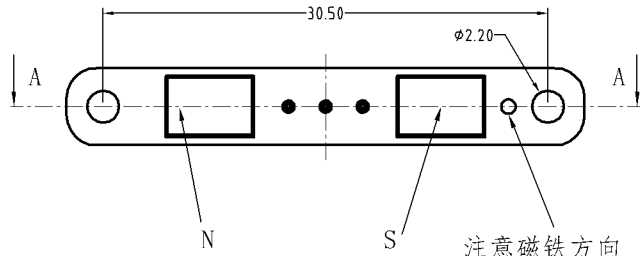
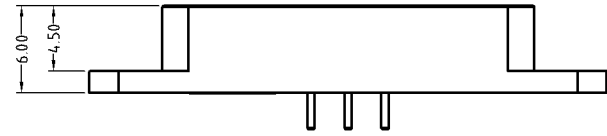
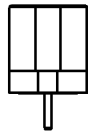

注意磁铁方向

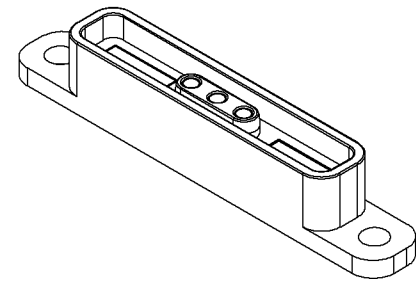

4	Pogo pin plating 0.125um Au <弹簧针 电镀金 0.125um>	B709-W1005	3
3	N52 NdFeB Magnet plating Ni-Cu-Ni <N52 钕铁硼磁铁 表面镀镍铜镍>	B647-M4104	1
2	N52 NdFeB Magnet plating Ni-Cu-Ni <N52 钕铁硼磁铁 表面镀镍铜镍>	B647-M3103	1
1	Black HTN UL94 V-0 <黑色 IITN UL94 V-0>	B709-H4004	1
序号 <NO.>	规格 <Specification>	料号 <P/\>	数量 <Qty>

SCALE	10:1	UNIT:mm	THIS DOCUMENT IS THE SOLE PROPERTY OF CFE CORPORATION CO.,LTD., AND SHOULD NOT BE USED IN WHOLE OR IN PART WITHOUT PRIOR WRITTEN PERMISSION.
ANGEL	±2°	A4	
0-6	±0.10		SHEET: 1 of 1
6-30	±0.20	DRAW	
30-150	±0.30	CHECK	
GENERAL TOLERANCE UNLESS OTHERWISE NOTED		APPRO	

东莞市川富电子有限公司 CFE CORPORATION CO.,LTD.	
PART NO.	M-BP70901-03254A0B
FILE NAME	BP709XX
TITLE.	Pogo pin Connector

ECN(DCN) NO.	REV	DATE	DESCRIPTION
	D0	2016.05.20	NEW