

Note: <注意>
 Mechanical: <机械性能>
 .Single pin spring force: 70g±20g at 1.0mm working stroke
 <单针弹力: 70g±20g在1.0mm的工作行程>
 .Mechanical Life : 50,000 cycles
 <机械寿命: 50000次>
 Electrical: <电气性能>
 .Rated current & voltage: DC 12V, 2A Max.
 <额定电压, 电流: DC 12V, 2A>
 .When the current is greater than 1A then need to increase the time delay circuit(3 second)
 <100%导通, 短路测试>
 100% open & short test.
 <100%导通, 短路测试>
 专利号: 见CFE产品专利说明

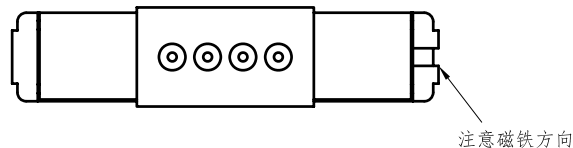

Approve Sign

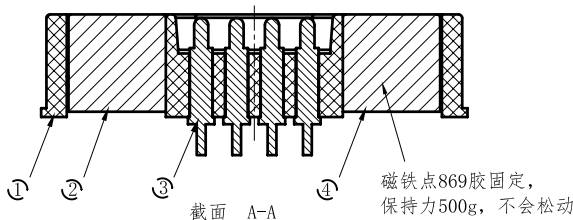
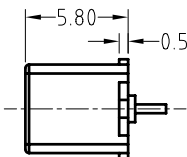
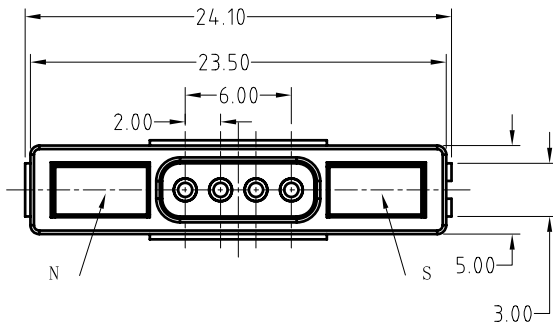
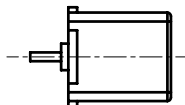
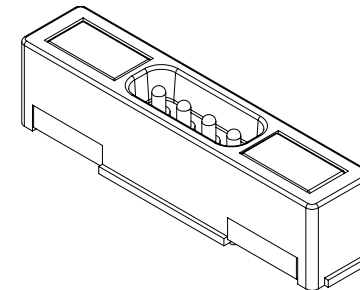
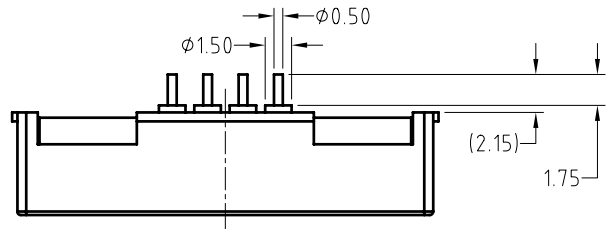

4	N48 NdFeB Magnet plating Ni-Cu-Ni <N48 钕铁硼磁铁 表面镀镍铜镍>	0200018-2100	1
3	Pogo pin plating 0.125um Au <弹簧针 电镀金0.125um>	MP820-2111	1
2	N48 NdFeB Magnet plating Ni-Cu-Ni <N48 钕铁硼磁铁 表面镀镍铜镍>	0200018-1100	1
1	Black HTN UL94 V-0 <黑色 HTN UL94 V-0>	0300046-1001	1
序号 <NO.>	规格 <Specification>	料号 <P/N>	数量 <Qty>

SCALE	10:1	UNIT:mm	THIS DOCUMENT IS THE SOLE PROPERTY OF CFE CORPORATION CO.,LTD., AND SHOULD NOT BE USED IN WHOLE OR IN PART WITHOUT PRIOR WRITTEN PERMISSION.
ANGEL	±2°	A4	
0-6	±0.10		SHEET: 1 of 1
6-30	±0.20	DRAW	
30-150	±0.30	CHECK	
GENERAL TOLERANCE UNLESS OTHERWISE NOTED		APPRO	



PART NO. MMB000501-04A1A0

FILE NAME MXB0005

TITLE. Magnetic connector/磁吸连接器

ECN(DCN) NO.	REV	DATE	DESCRIPTION
	D0	2016.07.30	NEW