

Note: <注意>
 Mechanical: <机械性能>
 .Contact force: 70g±20g at 1.0mm working stroke
 <接触弹力: 70g±20g在1.0mm的工作行程>
 .Full stroke: 1.40mm
 <最大行程: 1.40mm>
 .Life test: 50,000 cycles
 <寿命: 50000次>
 Electrical: <电气性能>
 .Rated current & voltage: DC 12V, 2A Max.
 <额定电压, 电流: DC 12V, 2A>
 .Contact resistance: 50 milliohm Max.
 <接触阻抗: 50 milliohm Max.>
 100% open & short test.
 <100%导通, 短路测试>

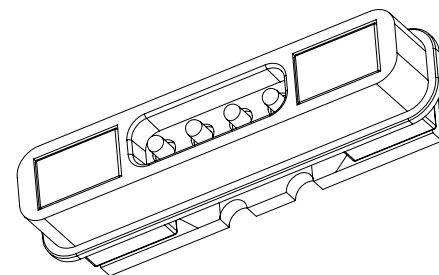

Approve Sign

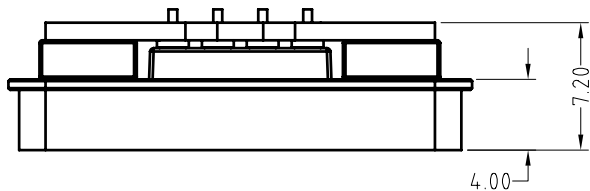
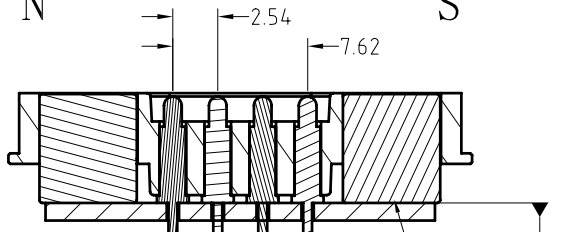
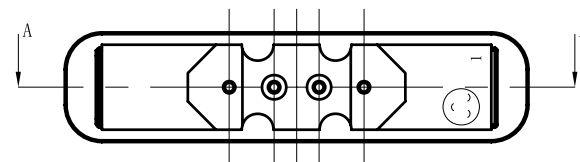
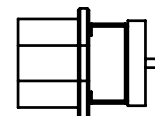
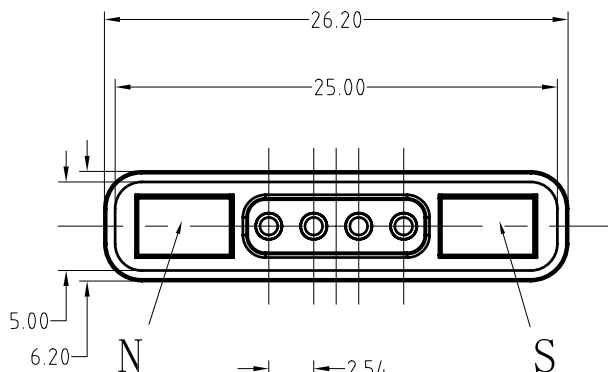
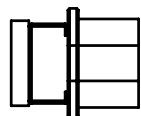

截面 A-A

磁铁点胶固定, 不会被吸附出来

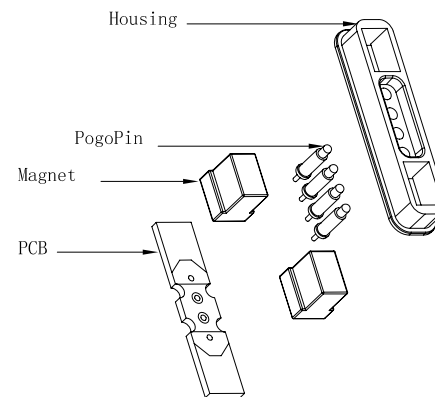

4	PCB Polyester fiber board <PCB 聚酯纤维板>	B633-F1100	1
4	Pogo pin plating 0.25um Au <弹簧针 电镀金0.25um>	MP210-2122	4
3	N52 NdFeB Magnet plating Ni-Cu-Ni <N52 钕铁硼磁铁 表面镀镍铜镍>	B633-M1100	1
2	N52 NdFeB Magnet plating Ni-Cu-Ni <N52 钕铁硼磁铁 表面镀镍铜镍>	B633-M2100	1
1	Black HTN UL94 V-0 <黑色 HTN UL94 V-0>	B633-H1001	1
序号 <NO.>	规格 <Specification>	料号 <P/N>	数量 <Qty>

SCALE	10:1	UNIT:mm	THIS DOCUMENT IS THE SOLE PROPERTY OF CFE CORPORATION CO.,LTD., AND SHOULD NOT BE USED IN WHOLE OR IN PART WITHOUT PRIOR WRITTEN PERMISSION.
ANGEL	±2°	A4	
0~6	±0.10		SHEET: 1 of 1
6~30	±0.20	DRAW	
30~150	±0.30	CHECK	
GENERAL TOLERANCE UNLESS OTHERWISE NOTED		APPRO	



PART NO. M-BP63311-04254H0M

FILE NAME BP633XX

TITLE. Pogo pin Connector

ECN(DCN) NO.	REV	DATE	DESCRIPTION
	A0	2016.09.12	NEW